

MOSO[®] by Grad Bamboo X-treme[®] installed in one click



📷 Lior Teitler



MOSO®

Bamboo X-treme®



With Bamboo X-treme®, MOSO® has developed a truly **ecological** and **durable** decking product. MOSO® uses a unique process to enhance **hardness**, **dimensional stability**, **fire resistance**, and **durability** to a level **superior** to that of the strongest tropical hardwood species.

durability class according to EN 350 (CEN/TS 15083-2 / CEN/TS 15083-1)

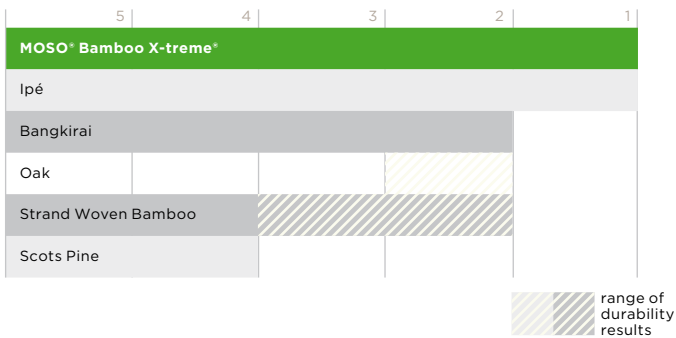

CO₂ footprint according to LCA by TU Delft (ISO 14040/44)

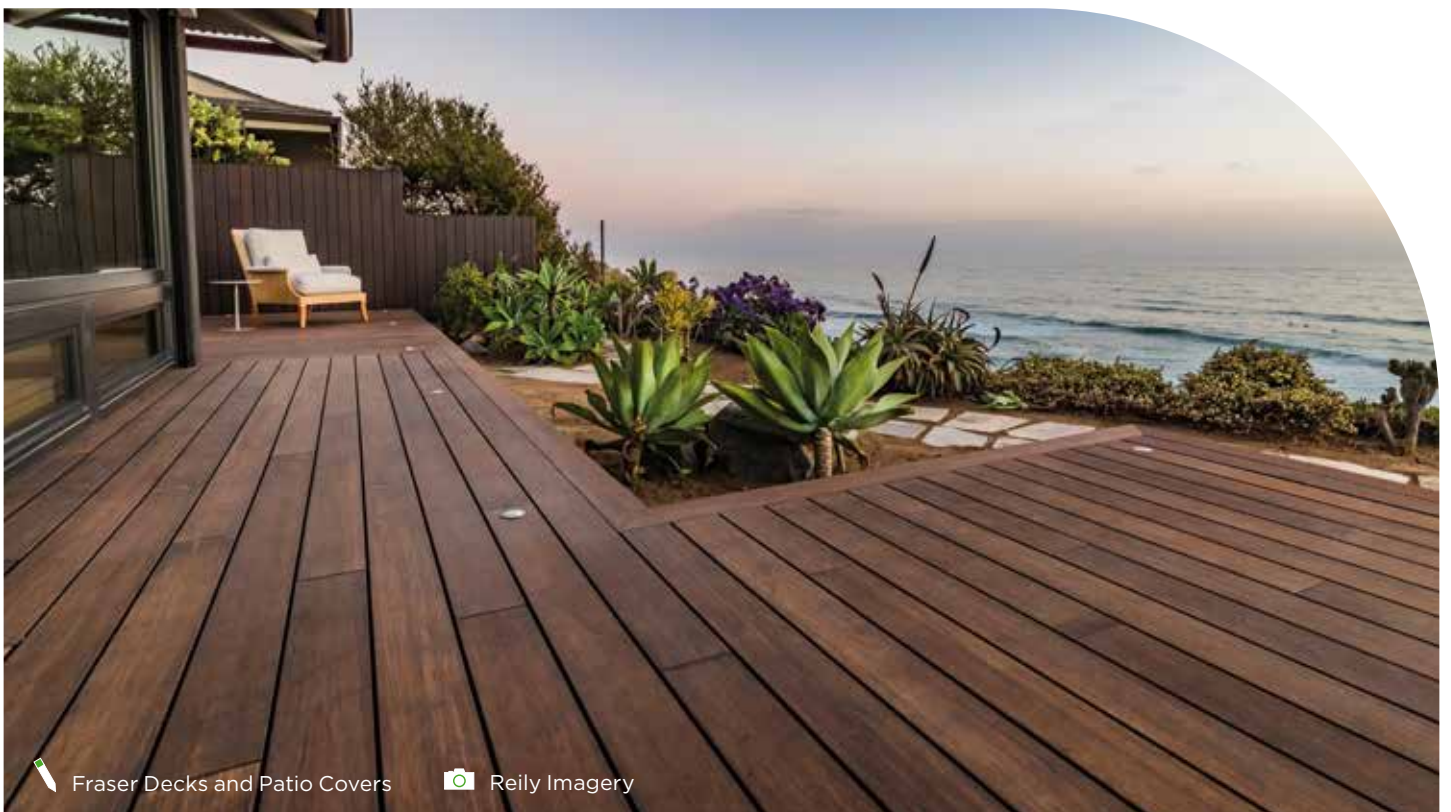
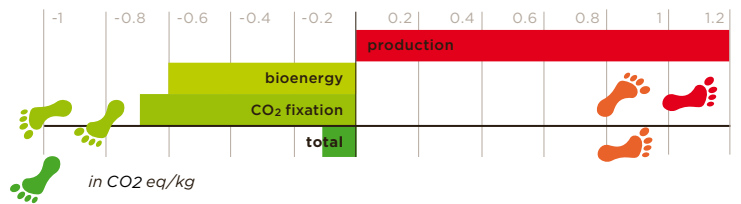

Grad installation system

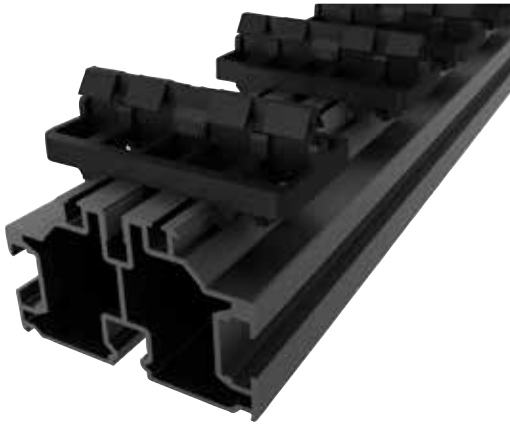

How it works: **Bamboo X-treme® boards** are snapped onto the **Grad clips** that fit into the **grooves at the backside** of the boards. Grad aluminium rails (available in 4 different heights) with pre-fixed clips, and multiple accessories to finish the deck, allow for a **fast, easy and reliable installation**, and ensure the perfect alignment of the Bamboo X-treme® board to create a decking that lasts.

invisible fasteners on Grad rails with the Grad clips

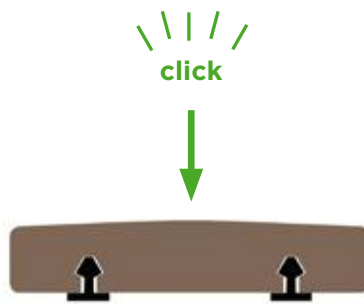
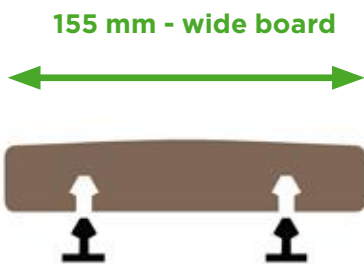

Grad keys for an easy to remove decking



MOSO® by Grad

Bamboo X-treme®



CO₂ neutral

- Official LCA and carbon footprint studies by Technical University Delft according to ISO 14040/44 confirm that MOSO® Bamboo X-treme® is CO₂ neutral over the full life cycle.
- No use of fungicide in the production.



high stability

- The thermo treatment combined with High Density compression renders the boards far more stable compared with traditional tropical hardwoods and limits its tendency to torsion.
- Aluminium is not subject to corrosion; its properties are not altered over time.
- 155 mm - wide boards with curved surface to allow for water drainage.
- Gaps of 4-5 mm are respected between all boards to ensure continuous ventilation.



fire resistant

- Meets fire resistance Class Bfl-s1 as per EN 13501-1 without the addition of fire retardant. As a result, MOSO® Bamboo X-treme® can be easily applied in public projects without additional protective measures.
- Meets Class A flame spread index as per ASTM E84.



hard & durable

- The bamboo decking with the durability Class 1 (EN 350) tested following CEN/TS 15083-2 class (simulated graveyard test).
- Use Class 4 in accordance with EN 335.
- Class 0 fungi resistance in accordance with EN 152.
- Exceptionally hard: Brinell >9.5 kg/mm² (harder than any tropical hardwood available).



MOSO®
Bamboo X-treme®:
made of the fastest
growing plant
in the world



certified

durable



fire resistant



sustainable



proven

Since 2008 over
3.5 million m²
Bamboo X-treme®
decking installed,
in more than
60 countries.



discover the **benefits**



economical

- 20% faster compare to installation with standard clip.
- Lengths of boards and aluminium rails optimised to minimise transportation costs.
- Tried and tested system offering a 30-year warranty on the subdeck.



easy to install/remove

- Easy set-up thanks to the combination of aluminium rails, clips, and pedestals from the Grad system.
- The aluminium rails are delivered already equipped with the Grad clips spaced at the right distances for first time perfect board alignment and fixed gaps between boards all around.
- The Grad 3D designing software guides all your project creations.
- Boards can be removed and put back effortlessly into place, and the subdeck can be accessed at anytime.



Grad clip

- Fasteners made of 100% recycled polymer (POM).
- Extreme heat and cold resistant (-40°C to 70°C).
- Pull-out resistance of 240 kg per board (fixed by 2 fasteners).

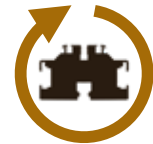

Grad rails

- Extreme stability and durability.
- Up to 90% of the aluminium used in the Grad rails comes from recyclable sources.

Grad installation system: reliable, fast and accurate



quote on request



Lépine gold medal -
Paris + world of the
inventors Geneva -
2008

proven

Since 2006, over
1.4 million m² of
Grad system has
been **installed**,
100% satisfaction
everytime.

30
years of
warranty on the
structure

WARRANTY
25
YEARS

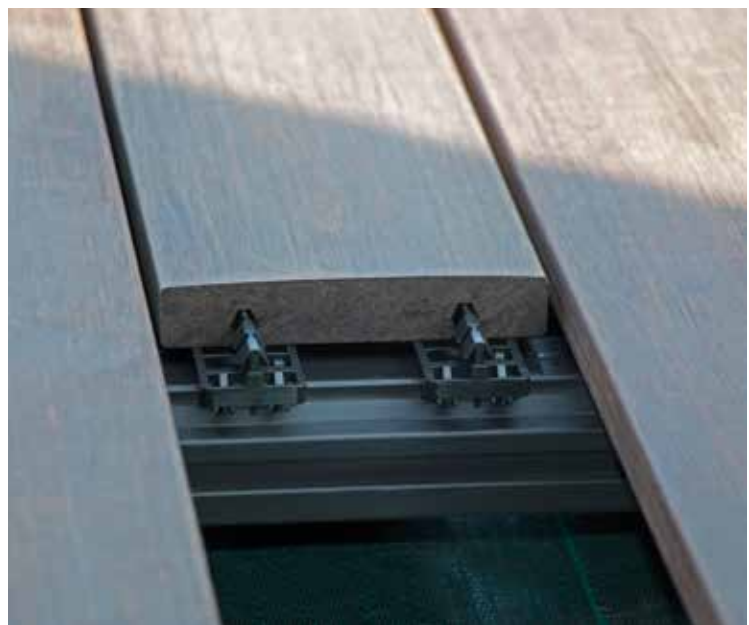

MOSO® Bamboo X-treme® Outdoor Decking

for Grad installation system

MOSO® Bamboo X-treme® is a solid, Thermo-Density® decking board, made from compressed bamboo strips. A special, unique heat-treatment process at 200°C provides Bamboo X-treme® with the highest durability class possible in the appropriate EU norms and increases the hardness and stability. The boards are precisely profiled to be installed on the Grad system. Like any untreated tropical hardwood species, when exposed to outdoor conditions, Bamboo X-treme® will turn grey over time creating a very natural look.



Smooth

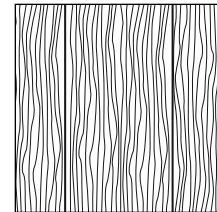

High Density*

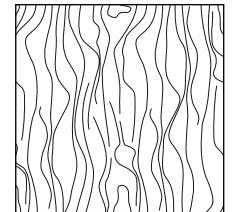

O: Oil Woca (the end of the boards are protected with wax), B: Bevel (also on ends).

Product Code	Surface	Finish	Grooved	End-matched	Edges	Dimensions (mm)
BO-DTHT190-C-BG	Smooth	-	Grad system	No	B	1850x155x21
BO-DTHT191-C-BG	Smooth	O	Grad system	No	B	1850x155x21

installation summary

(full version available on www.moso-bamboo.com/x-treme)

- Install a suitable, fixed, stable and durable sub frame.
- Fix the boards on Grad sub frame and follow Grad's installation instructions:
 - www.gradconcept.com/en/our-products/our-brochures
- Thanks to the curved surface installing with a slope is not required.
- After installation: make sure proper cleaning and maintenance is done, according to the chosen finish.
- When not applying outdoor oil regularly, the deck will acquire a grey colour tone and the typical bamboo wood grain structure will become less visible.
- Bamboo X-treme® is available pre-oiled or unfinished. Final treatment after installation with water based oil/ saturator is necessary for all versions.

technical characteristics and certifications

- Density: +/- 1150 kg/m³
- Dimensional stability: length: + 0.1 %; width + 0.9% (24 hours in water 20°C)
- Resistance to Indentation - Brinell Hardness: ≥ 9.5 kg/mm² (EN 1534)
- Reaction to fire: Class Bfl-s1 (EN 13501-1)
- Flame spread index: Class A (ASTM E84)
- Slip resistance: USRV 55 (Dry), USRV 29 (Wet) (CEN/TS 15676) / R 10 (CEN/TS 16165 Annex B - DIN 51130) (Dry)
- Thermal emittance: 0.81 (ASTM C1371) ¹⁾
- Solar Reflectance (SR): 0.32 (ASTM C1549) ¹⁾
- Solar Reflectance Index (SRI): Low 27, Medium 30, High 33 (ASTM E1980) ¹⁾
- Modulus of Elasticity: 13565 N/mm² (mean value - EN 408)
- Breaking strength: 54.4 N/mm² (characteristic value - EN 408)
- Biological durability: Class 1 (EN 350 / CEN/TS 15083-2), simulated graveyard test / Class 1 (EN 350 / CEN/TS 15083-1)
- Effectiveness against Blue Stain: Class 0 (EN 152)
- Use Class: Class 4 (EN 335)
- CO₂ neutral: LCA report TU Delft (ISO 14040/44) (www.moso.eu/lca)
- Environmental Product Declaration - EPD (EN 15804) (www.moso.eu/epd)
- FSC®: Products available with FSC® certification on request.
- Contribution LEED BD+C - v4: MR 1, MR 2, MR 3 (FSC®), EQ 2, SS 7 v2009: MR 6, MR 7 (FSC®), IEQ 4.3, IEQ 4.4
- Contribution BREEAM: MAT 1, MAT 3 (FSC®), MAT 5 (HD)
- Guarantee: 25 years

¹⁾ Tested on 3 years weathered MOSO® Bamboo X-treme®.



The mark of responsible forestry
FSC® C002063



breeam

MOSO[®] by Grad

Bamboo X-treme[®]

installation system

12 mm Flat Rail to complete the deck installation

- GRAD1800-FR-155
- GRAD1489-TOP-LINK

Plot adjustable from 35 to 380 mm

- GRAD1181-TOP-LFT
- GRAD1641-TOP-LFT-EX
- GRAD1499-TOP

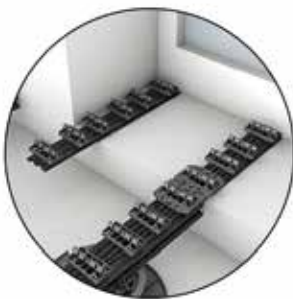

- GRAD1815-RD
- GRAD1503-BOW

- GRAD1504-ADJUST+

Unique tool to ensure fixed spacings



Various skirtings available for perfect decking finishing



Up to 800 kg per pedestal (spread load)



- GRAD1181-TOP-LFT
- GRAD 1802-PR39-155
- GRAD1816-BANNER
- GRAD1498-TOPCUBE

- GRAD1505-ADJUST

MOSO® by Grad

installation system

MOSO® by Grad rails including fasteners

With these rails and fasteners, MOSO® Bamboo X-treme® Decking can be easily installed. When installed correctly, there will be 4 mm gaps between length boards for ventilation.

Product Code	Description	Dimensions (mm)	Effective height	Consumption	Distance between pedestals*	Quantity per pallet (units)
GRAD1800-FR-155	Flat Rail 155 - 55/12 (for 12 boards)	1920 x 63 x 30	18 mm	1,2 rail/m ²	continuous support	216
GRAD1808-TR24-155	TR 24 155 - Top Rail (for 12 boards)	1920 x 63 x 70	35 to 90 mm	1,2 rail/m ²	32 cm	120
GRAD1802-PR39-155	PR39 155 - Perfect Rail (for 12 boards)	1920 x 63 x 57	45 mm	1,2 rail/m ²	65 cm	108
GRAD1803-PR56-155	PR56 155 - Perfect Rail (for 12 boards)	1920 x 63 x 74	62 mm	1,2 rail/m ²	100 cm	108
GRAD1815-RD	DIV 463 - Connector Rail	1910 x 63 x 44	32 mm	0,3 piece/m ²		72

*) Distance between plots indicated for residential use. For non-residential use, please contact MOSO®.

Flat Rail
GRAD1800-FR-155



Top Rail
GRAD1808-TR24-155



Perfect Rail
GRAD1802-PR39-155



Sub Rail
GRAD1803-PR56-155



Connector Rail
GRAD1815-RD



MOSO® by Grad accessories

Depending on the installation, special Grad accessories are required to install the Bamboo X-treme® decking.

Product code	Description	Material	Quantity per box	Quantity per pallet
GRAD1181-TOP-LFT	TOP LIFT	PP - adjustable from 35 to 55 mm without extension.	1	960
GRAD1641-TOP-LFT-EX	UP+	PP - 45 mm height are added per pair of assembled extensions.	2	7680
GRAD1499-TOP	TOP+	PP - to stabilize the plot beyond 3 pairs of extensions.	80	1920
GRAD1489-TOP-LINK	TOP LINK L	POM - Rail connection piece.	20	4800
GRAD1483-CLIPGRAD	CLIP GRAD	POM + stainless steel - removable clip 6cm with lugs for alu rail, bag of 50.	50	16000
GRAD1487-CLIPGRADSE	CLIP GRAD SE	POM + stainless steel - fasteners without lugs for angled segments and screw M5/12, kit of 50.	50	16000
GRAD1503-BOW	BOW	Stainless steel - bracket kit 47/30 including bolts (for attachment of distributors and creation of trimmers), bag of 4.	4	8192
GRAD1505-ADJUST	ADJUST	Stainless steel - adjustable plate 120/30/1.5 mm to connect rails with variable angles including bolts, kit of 2.	2	7680
GRAD1504-ADJUST+	ADJUST+	POM + stainless steel - adjustable plate 120/30/1.5 mm to connect fascias with variable angles including unit clip, kit of 4.	4	5120
GRAD1784-KEY	KEYS M	High strength steel - pair of keys to remove 155 mm boards.	2	2160

Top Lift
GRAD1181-TOP-LFT



Up+
GRAD1641-TOP-LFT-EX



Top+
GRAD1499-TOP



Top Link L
GRAD1489-TOP-LINK



Clip Grad
GRAD1483-CLIPGRAD



Clip Grad SE
GRAD1487-CLIPGRADSE



Bow
GRAD1503-BOW



Adjust
GRAD1505-ADJUST



Adjust+
GRAD1504-ADJUST+



Keys M
GRAD1784-KEY



MOSO® by Grad

finishes

MOSO® by Grad deck finishing

The Grad system provides unique skirting features for an elegant finish of the decking all around.



Product code	Description	Material	Quantity per box	Quantity per pallet (pieces)
GRAD1498-TOPCUBE	TOP CUBE	POM + stainless steel - to be clipped on the TOP CUBE in order to finalize your decking by adding endprofile board.	4	1920
GRAD1816-BANNER	END1 155	Alu + POM + stainless steel - is fixed on the TOP CUBE, for 1 board with a height of 155 mm.	25	2400
GRAD1817-BANNER	END2 155	Alu + POM + stainless steel - is fixed on the TOP CUBE, for 2 boards with a height of 155 mm.	25	1400
GRAD1486-CALCLIP	CAL CLIP	POM + stainless steel - is used in the case of an edged board with only one groove left.	20	12000

Top Cube
GRAD1498-TOPCUBE

End1 155
GRAD1816-BANNER

End2 155
GRAD1817-BANNER

Cal Clip
GRAD1486-CALCLIP



MOSO® maintenance & cleaning accessories for Bamboo X-treme® decking

Under the influence of wind, rain, sun and snow the decking will weather. MOSO® recommends to impregnate and maintain the pre-oiled decking with Woca Maintenance materials. Unfinished decking must be treated with Sikkens Saturator or Woca oil right after installation. The silicium carbid broom and machine disk are perfectly suited to clean and smooth the decking surface of Bamboo X-treme® and to remove splinters due to the capability to sand the surface in addition to cleaning it.

Product Code	Material
DISK-01	16" Silicium carbid disk
BROOM-01	Silicium carbid broom
SATURATOR-SIK01	SIKKENS Saturator lpe
SATURATOR-SIK11	SIKKENS Saturator Transparent

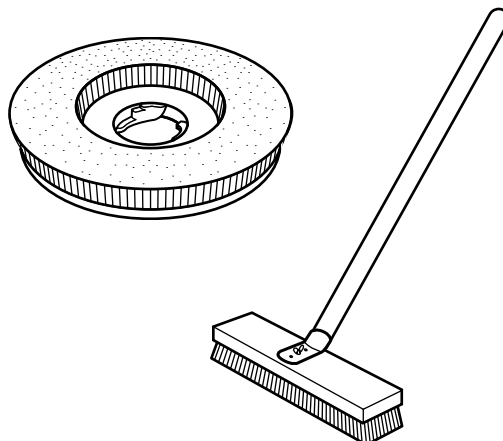

MOSO® Bamboo X-treme® Outdoor Decking

user information, maintenance & cleaning



Gradual greying of MOSO® Bamboo X-treme® over time: new, non-weathered decking (left), after 3 months of weathering (middle) and after 18 months of weathering (right).

appearance and colour

MOSO® Bamboo X-treme® is a natural product, which can vary in colour, grain and appearance. Colour will change over time depending on the maintenance schedule. The boards have a brown to dark brown colour when installed, which turns into a lighter caramel colour several weeks after installation. Without further maintenance the colour gets greyish relatively fast (similar to most other wood species).

If a brown colour is preferred, maintenance should be done with WOCA exterior oil (Teak colour) or Sikkens Cetol WF771 saturator oil (Ipé colour), or a comparable water based oil/saturator with Ipé or Teak pigments (for the unfinished version).

Directly after installation, 1 layer of oil must be applied.

See for further details the installation instructions. MOSO® Bamboo X-treme® shows similarity to other hardwoods in grain and structure. The characteristic bamboo nodes however can still be recognized and gives the product a special and lively look.

swimming pool

If MOSO® Bamboo X-treme® outdoor decking is to be used around swimming pool areas, the following has to be taken into account: MOSO® Bamboo X-treme® is a natural (wood like) product.

As with any wooden product used outdoors, there is always a risk of formation of splinters, however splinters from MOSO® Bamboo X-treme® are normally smaller than (tropical) hard wood splinters. A regular application of oil (more frequently necessary around swimming pools) is required to reduce the formation of splinters. Furthermore, regular maintenance with the silicium carbid broom or -disk is required to effectively remove splinters and smoothen the surface.

normal phenomena

Cracks on the surface and on the end of the boards can arise from the different drying characteristics of the surface and cross cut ends. This does not affect the stability or durability of the board.

The surface sides of the boards will get rougher over time and will form (small) splinters as a result of continuous water absorption and desorption due to dry and wet weather periods. Dimensional change, grain raise or cupping of the boards can occur after installation. These phenomena are normal for most hardwood species and MOSO® Bamboo X-treme®.

Like many wood species, some tannins can come out of the Bamboo X-treme material and into the water when it gets wet, e.g. when it rains. This is a normal phenomenon and will decrease over time. The brownish liquid can easily be cleaned from the Bamboo X-treme material, however be careful of possible staining of materials adjacent to or below the Bamboo X-treme (i.e. white walls underneath a balcony).

maintenance with Sikkens Cetol WF771

The maintenance and cleaning of the MOSO® Bamboo X-treme® decking is similar to other tropical wood, with the difference that the waterbased saturator oils provide greater protection than traditional oils. Sikkens Cetol WF 771 water based saturator oil is recommended for optimal protection.

cleaning

- Wet the deck well with clean water. Apply SIKKENS WV 840 with a synthetic roller (wall roller with long pile) or a brush.
- Scrub the greyer parts with a nylon brush.
- Leave on for 15-20 minutes.
- Rinse thoroughly with plenty of water or water at high pressure (maximum 60 bar and 50cm away from the surface of the deck to avoid damage). Do not use strong jets of water close to the surface, as this may cause the fibres to lift and the bamboo material to be damaged.
- Allow the bamboo a minimum of three days to dry in warm, dry weather
- You can then apply the waterbased saturator SIKKENS Cetol WF 771.

application of oil

- Always make sure the decking is clean, dry, free of dust or dirt, and without any coating. Never work on a deck in direct sun.
- Brush the deck with a silicium carbid brush or machine disk. If this does not give a satisfactory result, the surface can be sanded using a machine with 80 grit.
- Stir the saturator oil before and during the application to avoid colour variation.
- Apply a generous layer of saturator with a brush, or with an air gun (35 to 65 bar) on the working surface.
- Important: remove any excess product before it dries, to avoid any dripping or glossy areas. The saturator must penetrate the material and not remain on the surface, so that it dries leaving a matt look.
- Pay attention to the head end joints and cut ends, which tend to absorb more water, and saturate well to minimise water ingress.

theoretical yields

- WV 840: 8 to 15 m² / litre.
- Cetol WF 771 IPE for the first treatment: 10 - 12 m² / litre (for 1 coat of saturator).
- Cetol WF 771 - for periodic maintenance: 14 to 15 m² / litre (for 1 coat of saturator).

maintenance flat side

Please be aware of the fact that on the flat surface, irregularities in the surface (e.g. cracks, splinters) are better visible than on the reeded surface. If regular maintenance with a water based decking oil is performed, this will be reduced.

risk of self-ignition

Due to the risk of self-ignition it is important that oil-wetted cloths are soaked in water and are disposed in a tightly closed container after use.



Surface of MOSO® Bamboo X-treme® with different maintenance and cleaning scenarios: weathered, dirty decking (left), weathered, cleaned decking (middle), and re-oiled decking (right).



see the ease and fast installation
of MOSO® by Grad on:
www.moso-bamboo.com/grad

MOSO® by Grad **Bamboo X-treme®**: unique and patented decking solution!



Headquarters:

Moso International B.V.
Adam Smithweg 2
1689 ZW Zwaag
The Netherlands
T +31 (0)229 265 732
info@moso.eu

Spain, France, Portugal, North Africa,
Latin America and Middle East:

Moso Europe S.L.U.
C/ Pau Claris, 83 - Principal 2ª
08010 Barcelona
Spain
T +34 (0)93 574 9610
contact@moso.eu

North America:

Moso North America Inc.
8400 B Remington Ave
Pennsauken, NJ 08110
United States of America
T: +1 855 343 8444
info@moso-bamboo.com

Sub-Saharan Africa:

Moso Africa Pty. Ltd.
7 Glosderry Road Kenilworth
7708 Cape Town
South Africa
T +27 2167 11214
contact@moso-bamboo.co.za

Gulf Cooperation Council
(GCC) Countries:

Moso Middle East LLC
202 Al Mansour Bldg.
Damascus Road, Al Qusais
P.O. Box: 384421, Dubai
United Arab Emirates
T: +971 4 258 9337
contact@moso.ae

Italy:

Moso Italia S.R.L.
Via Antonio Locatelli 86
20853 Biassono (MB)
Italy
T +39 (0)39 900 5440
mosoitalia@moso.eu

www.moso-bamboo.com



**bamboo
products**